

# Step 1

## Get the Wynd App

Get the Wynd app to unlock all of Wynd's features including Air ID, device monitoring, and more.

To pair your Halo to your other smart devices, download the Wynd App from:



Halo is compatible with Alexa, Honeywell Home, and more. To see all smart device integrations, open the app.

# Step 2

## Controlling Wynd Halo

Hold the Wynd logo on the front for 1 second to turn it ON.  
Hold it for 2 seconds to turn it OFF.  
Press it to select options.

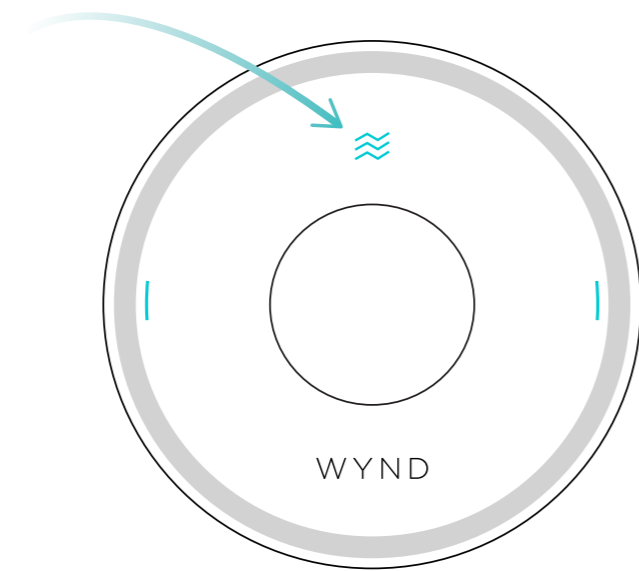

# Step 3

## Navigating Wynd Halo

Press the right and left indicators to navigate options.

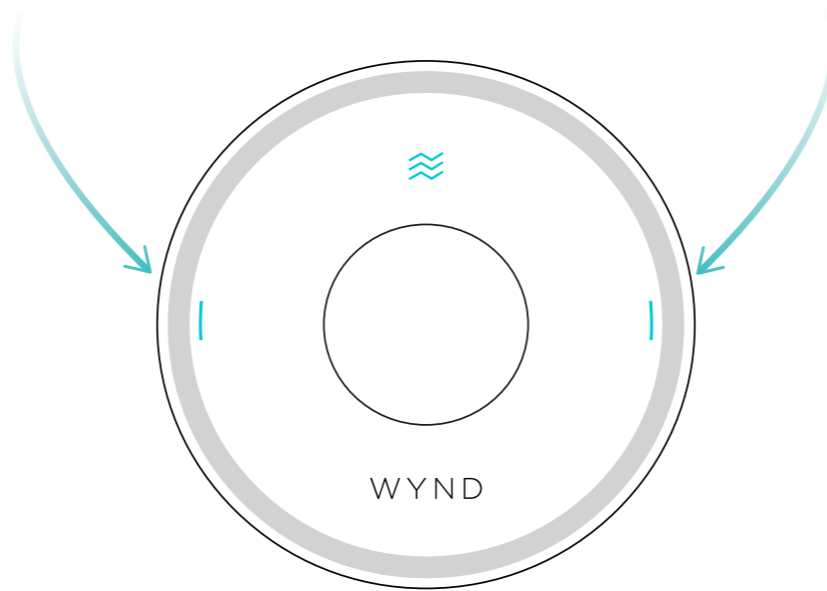

# Monitoring

## Monitor Your Air

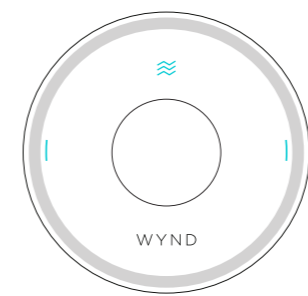

Halo monitors PM 1, PM 2.5, PM 4, PM 10, VOC, CO2, temperature, humidity, light, noise, pollen, dander, smoke, and smog.

The color of the ring around the face indicates general air quality, and the Wynd score (0 - 100) gives you more granular air quality feedback.

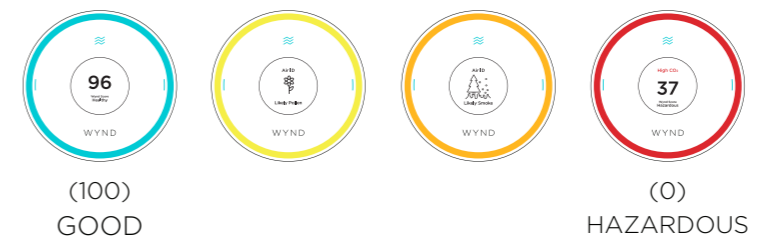

# Charge

## Charge Halo

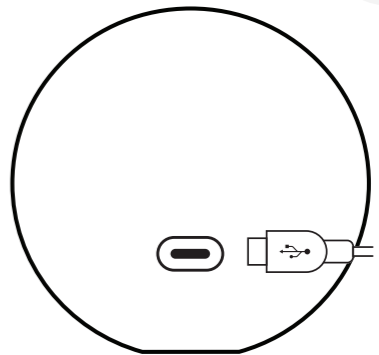

Plug in the supplied USB-C cable to the wall mount or Halo charge port.

When charging, a battery icon will appear at the bottom of the screen.

Make sure to use our supplied cable to protect Halo from low-quality third-party cables!

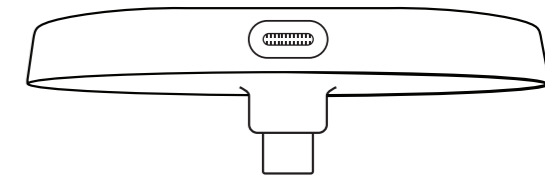

To charge via the wall mount, insert supplied USB-C cable into the slot on the bottom of the mount.

# Wall Mount

## Install Wall Mount (optional)

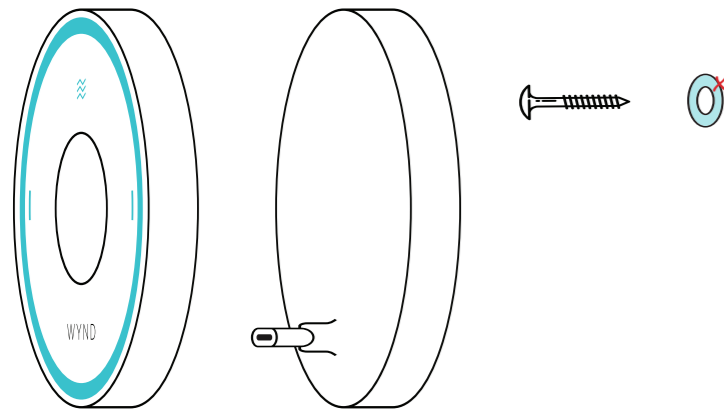

1. Use the washer (indicated by red X) as a spacer when drilling in the screw. Stop when the screwhead touches the washer.
2. Remove the washer and dispose of it. Then hang the wall mount on the screw.
3. Plug Halo on the wall mount or take it on the go!

# Tips

## Other Tips

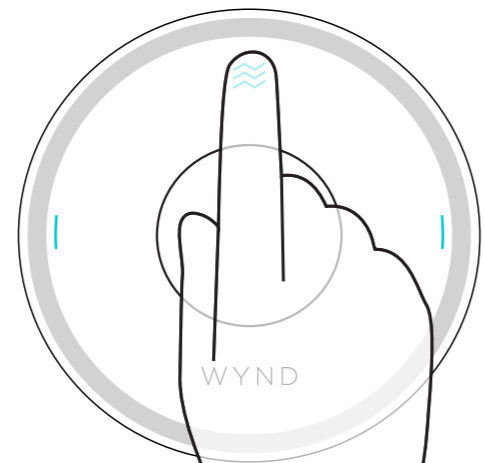

- **Problems?** Try holding down the Wynd logo at the top of the device for 10 seconds to restart the device.
- If the Halo does not turn on, charge it for 5 hours before using it unplugged. You can still use it while it's charging!

# Contact

## Contact Us

Questions or feedback

[support@hellowynd.com](mailto:support@hellowynd.com)

Warranty details

[hellowynd.com/warranty](https://hellowynd.com/warranty)

Detailed instructions

[hellowynd.com/instructions](https://hellowynd.com/instructions)

Any changes or modifications not expressly approved by the party responsible for compliance could void the user's authority to operate the equipment.

This device complies with part 15 of the FCC Rules. Operation is subject to the following two conditions:

- (1) This device may not cause harmful interference, and
- (2) This device must accept any interference received, including interference that may cause undesired operation.

### Note:

This equipment has been tested and found to comply with the limits for a Class B digital device, pursuant to part 15 of the FCC Rules. These limits are designed to provide reasonable protection against harmful interference in a residential installation. This equipment generates, uses and can radiate radio frequency energy and, if not installed and used in accordance with the instructions, may cause harmful interference to radio communications. However, there is no guarantee that interference will not occur in a particular installation. If this equipment does cause harmful interference to radio or television reception, which can be determined by turning the equipment off and on, the user is encouraged to try to correct the interference by one or more of the following measures:

- Reorient or relocate the receiving antenna.
- Increase the separation between the equipment and receiver.
- Connect the equipment into an outlet on a circuit different from that to which the receiver is connected.
- Consult the dealer or an experienced radio/TV technician for help.

### FCC Radiation Exposure Statement:

This equipment complies with FCC radiation exposure limits set forth for an uncontrolled environment. This transmitter must not be co-located or operating in conjunction with any other antenna or transmitter.

### Other Statement:

The charging cable provided is a supplemental free item and is not part of the Wynd product purchased.

### Operating Frequency Band:

Halo unit: 2.4 GHz  
Max. of transmit power: +16 +/- 2dBm

The Wynd Halo transmits data to the mobile app and the mobile app transmits data to the Wynd Purifier.

# Setup your Wynd Halo in 3 easy steps

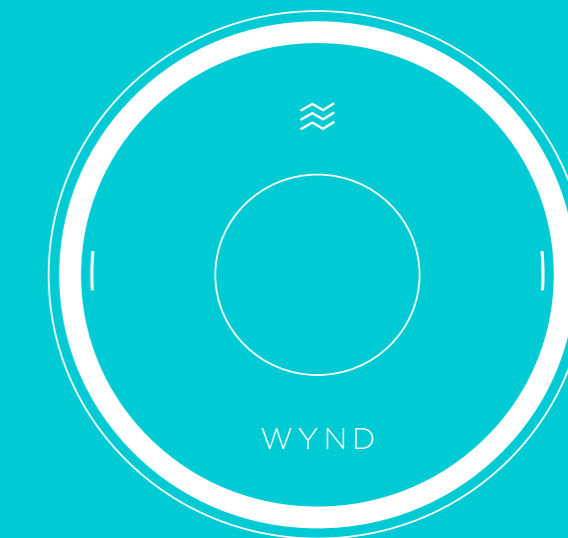

Step 1 →